

ANCHOR POINT FOR PERSONAL FALL PROTECTION EQUIPMENT ON WATERPROOFING MEMBRANE ROOF

INSTALLATION

Installation on bitumen-based membrane and PVC-based membrane shall be done in accordance by:
INSTRUCTIONS FOR INSTALLATION AND MAINTENANCE MOUNTING PLATE, WATERPROOFING MEMBRANE ROOF

- Anchor point may be installed in different directions.
- Installation shall be done with EPDM seal and M10 stainless steel nut.
- Tightening torque 10Nm.
- The anchor point is only intended for the attachment of 1 person, equipped with personal fall protection.

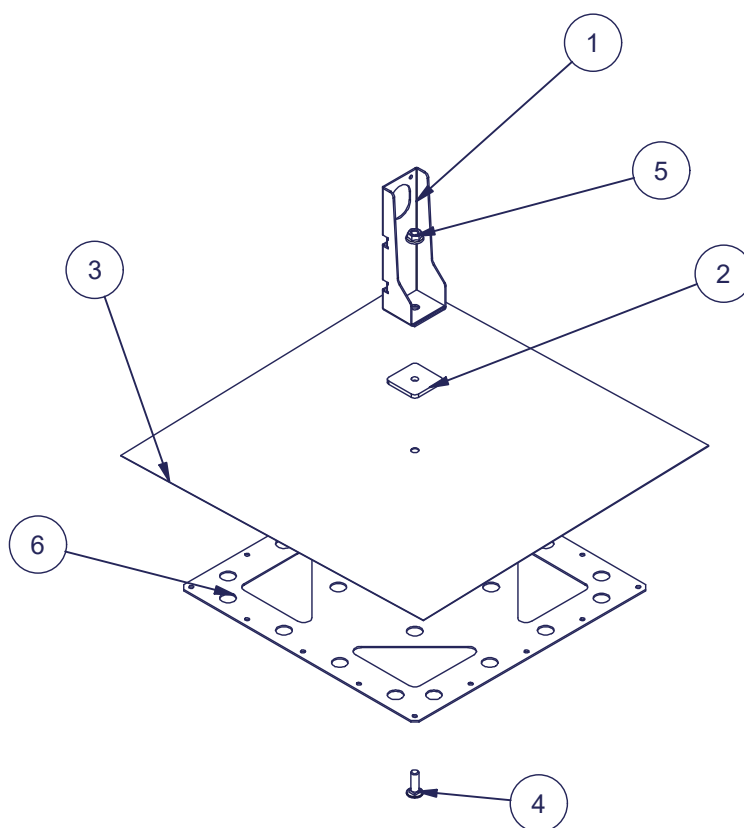

Part	Description	pcs
1	Anchor point	1
2	EPDM seal	1
3	Top sheet membrane	1
4	Mounting plate bolt A2 M10	1
5	Nut DIN 6923 - A2 M10	1
6	Mounting plate	1

USE

The anchor points are designed to be used on low pitched roofs (less than 1:8) as an additional safety device to ensure safety in case of sudden falling. Individual anchor points do not replace the need for roof walkways, ladders and continuous safety rails. It is not meant to be used under continuous load while working on the roof as this may damage the product and/or the roof.

Amount of needed anchor points per roof is to be determined by the designer. The mounting substrate (roof structure) should be strong enough to withstand a minimum of 10 kN static and dynamic loads coming from the anchor point. The arrangement should be designed so that it is easy and safe to move on the roof by using two adequate lifelines. The anchor points should not be installed next to the edge of the roof due to safety of use.

- Anchor point is a safety device that ensures safety in case of falling. One must not continuously work by loading the person's weight solely on the anchor point - this may damage the product and substructures
- Only one person at a time, with a total weight of max. 150 kg, including the equipment, is allowed to fix a safety rope to the anchor point
- Use proper, approved safety rope / lifeline only
- Before using the anchor point, perform a visual inspection of the product and make sure the connection of the product is tight and secure

MAINTENANCE

Pisko products are hard-wearing and safe to use, guaranteed by the ongoing quality control and development work by Piristeel Ltd, as well as correct installation of the products according to the manufacturer's instructions. To ensure the reliability and safety of the products, the property owner must carry out yearly inspection and maintenance procedures and monitor that the installed products and the substructure (roof surface) surrounding the products are in good condition.

Check the tightness of joints, connections, fixings and attached devices. Especially pay attention to the possible waterproofing membrane around the mounts and take necessary actions to repair the membrane according to manufacturer's instructions, if needed.

Carefully inspect for a proper adhesion and/or condition of the waterproofing membrane's surface around the mounts. Check the roof attachments (fixings). Ensure any excessive snow load is cleared to minimize the strain on structures, fixed devices and attachment points (as necessary; there might be a need to do this several times during the winter).

As necessary, clear the attached devices of snow and ice. Check the paintwork and metal coating of the Pisko-products; repair faults and touch up paintwork if necessary. Replace or repair any damaged or faulty parts as soon as possible to avoid any hazards.